



Project	
Nomenclature	
Type	Date
Approval	
Notes	

The BLSPC is an LED linear cove strip fixture designed for surface and suspended mounting. It is well suited for indoor use where high efficiency, row-mountable task lighting is required. Its narrow strip design and modern profile make it an ideal fixture for task lighting applications.

### Luminaire Summary

#### Features

- Operating temperature ranges available from -40C to 40C
- L70 of 99,000+ hours, L90 of 30,000+ hours
- Standard 0 - 10V dimming
- Available in 2700K, 3000K, 3500K, 4000K, 5000K and 6500K
- Lumen packages are available ranging from 1' 1.125L (1126lm) to 8' 23L (23191lm)

#### Approvals

- ETL certified to UL Canada and United States standards
- Made with UL Listed components

#### Mounting

- Holes provided for V-hangers, S-hook chain-mounting, or aircraft cables
- Optional pendant-mount and row-mount brackets
- Knockouts provided for row-mounting

#### Construction

- Manufactured in Ontario, Canada
- Powder-coated in high reflectance gloss white (other colours available)
- Precision bent for added strength and rigidity

#### Electrical

- Available in 120-277V, 120-347V, 347V and 480V

#### Options

- Custom lengths available
- Wireless Controls Available
- 90 and 95+ CRI Options Available
- 120-347V(UN3) Available

## Ordering Information

Fill in the fields below with your product selections. If you need help with this section, [contact your local sales professional](#).

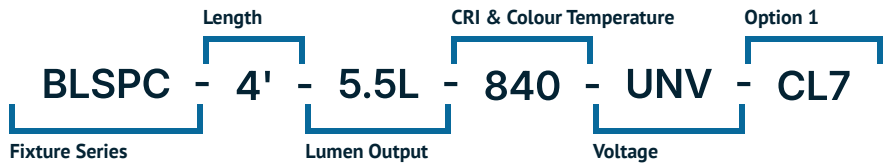

1	2	3	4	5	6
BLSPC					

Series	Length	Lumen Output		CRI	Colour Temp	Voltage		
BLSPC	1' - 1' (ft)	1' 1.125L	(1126 lm)	4' 10.5L	(10430 lm)	8 - 80 CRI	27 - 2700K	UNV - 120-
	4' - 4' (ft)	1' 1.375L	(1377 lm)	4' 11.5L	(11291 lm)	9 - 90 CRI	30 - 3000K	277V
	8' - 8' (ft)	2' 1.75L	(1755 lm)	8' 5L	(5345 lm)	1 - 95+ CRI	35 - 3500K	UN3 - 120-
	* - Custom	2' 2.25L	(2253 lm)	8' 7L	(7541 lm)		40 - 4000K	347V
		2' 2.75L	(2753 lm)	8' 9L	(9683 lm)		50 - 5000K	347 - 347V
		4' 2.5L	(2603 lm)	8' 11L	(11772 lm)		65 - 6500K	480 - 480V
		4' 3.5L	(3673 lm)	8' 13L	(13807 lm)			
		4' 4.5L	(4716 lm)	8' 15L	(15789 lm)			
		4' 5.5L	(5734 lm)	8' 17L	(17717 lm)			
		4' 6.5L	(6725 lm)	8' 19L	(19591 lm)			
		4' 7.5L	(7690 lm)	8' 21L	(21412 lm)			
		4' 8.5L	(8629 lm)	8' 23L	(23191 lm)			
		4' 9.5L	(9542 lm)	**L - Custom lumen package				

## Options

### Lenses

BLANK	No lens
-------	---------

### Cords

W3xx	White 16/3 (Specify Length)
W4xx	Black 16/3 (Specify Length)
W59xx	White 16/5 (Specify Length)
W***	Other Options Available*

Key	Cord Length	Key	Cord Length
6	6FT	15	15FT
10	10FT	20	20FT

Ex. W406 would be 16/3 Black, 6FT

### Motion Sensors

W26	Photocell Motion Sensor
W57	Dimming Motion Sensor (dims to 50% when unoccupied)
W53*	On/Off
W8*	High/Low
WX16	Microwave Dimmable Sensor
W**	Other Options Available*

### Wire Guard

G1	Heavy Duty White
G5	Heavy Duty Black

### Finish

BLANK	Standard Gloss White
C5	Matte Black
CUSTOM*	Custom Colour Choice

### Dimming

B11	0-10V Dimming Leads
B12	Line Voltage Dimming
B27	Dim-to-off Driver
B**	Other Options Available*

### Controls

WC10*	Encelium Wireless Controls
WC18*	NX Wireless Controls
WC19*	Avi-on Wireless Controls
WC22*	JDRF Wireless Controls

### Emergency Driver

B17	UL924 6W Battery Back-up
B24	UL924 10W Battery Back-up
F8	UL924 Emergency Relay

### Packaging

BLANK	Individually Boxed on Pallets
P0	Bulk Packaging
P**	Other Options Available*

### Mounting

M1	V-Hangers
M2xx	V-Hanger with Aircraft Loop Cables
M3xx	Y-Toggle Aircraft Cables
M24	Single Pendant Mount(3/4 Hub)
M**	Other Options Available*

Key	Aircraft Length	Key	Aircraft Length
5	5FT	15	15FT
10	10FT	20	20FT

Ex. M305 would be Y-Toggle, 5FT

### Modular Wiring

W27XYZC	Modular Power Cable
W22XY	Molex Row Mounting Wiring

See page 7

### Warranty

CL7	10-Year Comprehensive Warranty Upgrade
-----	--

## Documentation and Resources

All files and resources are available on our website for download. Files and resources are also embedded as links in this document, listed below. Additional files may be available upon request. Please contact your local sales agent [here](#) or contact [sales@bjtake.com](mailto:sales@bjtake.com) for more information.





 [BLSPC - Installation Instructions](#)

 [BLSPC-4FT-5.5L](#)

 [BLSPC-8FT-11L](#)

## Certifications and Listings

Certifications that apply to this fixture and its possible configurations are listed here. More information available upon request.

Icon	Description
	Wireless Controls Available
	ETL Listed
	90 and 95+ CRI Options Available
	120-347V(UN3) Available

## Usage Applications

This fixture can be used in a variety of applications, and is ideal for the following:

Usage Application
Manufacturing Facilities
Storage & Warehousing
Offices
Schools
Retail Stores
Distribution Facilities
Processing Plants
Aisle Lighting

## Warranty Statement

BJ Take products are tested and/or inspected prior to being packaged for shipment and are guaranteed from the day the product is shipped for a period of ten-year LED chip warranty and a five-year comprehensive component warranty. This can be upgraded to a ten-year comprehensive warranty on request.

### Important Information

Below you will find the available wattage charts for the BLSPC. For any required specifications that are not listed here, please contact our sales team at [sales@bjtake.com](mailto:sales@bjtake.com) to request any additional information.

### BLSP, 1/2/10 Foot, Wattage

Size	Lumen Output	Actual Lumen Output	Fixture Wattage	Lumens per Watt
1'	1.12	1291.60	8.32	155.20
1'	1.38	1570.95	10.23	153.60
2'	1.75	2012.44	12.80	157.20
2'	2.25	2584.30	16.63	155.40
2'	2.75	3140.82	20.47	153.40
10'	11.50	11560.00	74.90	154.10

### BLSPC, 4 Foot Wattage

Size	Lumen Output	Actual Lumen Output	Fixture Wattage	Lumens per Watt
4'	2.50	2852.70	17.90	159.10
4'	3.50	4023.79	25.60	157.20
4'	4.50	5167.50	33.30	155.40
4'	5.50	6281.63	40.90	153.50
4'	6.50	7367.27	48.60	151.60
4'	7.50	8425.53	56.30	149.80
4'	8.50	9454.21	63.90	147.90
4'	9.50	10454.41	71.60	146.00
4'	10.50	11426.12	79.30	144.20
4'	11.50	12369.35	86.90	142.30

### BLSPC, 8 Foot Wattage

Size	Lumen Output	Actual Lumen Output	Fixture Wattage	Lumens per Watt
8'	5.00	5855.48	35.70	163.90
8'	7.00	8261.21	51.00	162.00
8'	9.00	10607.78	66.30	160.10
8'	11.00	12896.29	81.50	158.20
8'	13.00	15125.65	96.80	156.20
8'	15.00	17296.94	112.10	154.30
8'	17.00	19409.07	127.40	152.40
8'	19.00	21462.05	142.60	150.50
8'	21.00	23456.97	157.90	148.60
8'	23.00	25405.87	173.30	146.60

### BLSPC, LLF (Light Loss Factor)

CCT	Output%
2700K	92.95
3000K	95.51
3500K	96.80
4000K	100.00
5000K	101.28
90CRI	84.72

### BLSPC, 1 Foot Side Dims

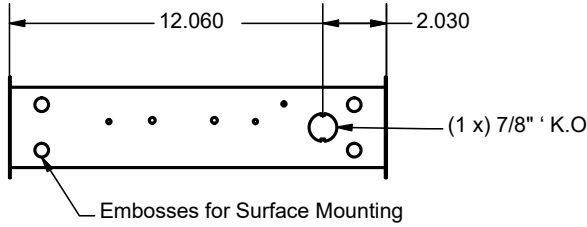

### 1FT End View

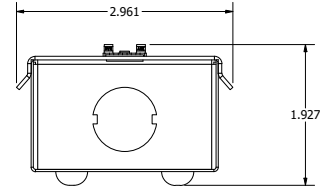

### BLSPC, 2 Foot Side Dims

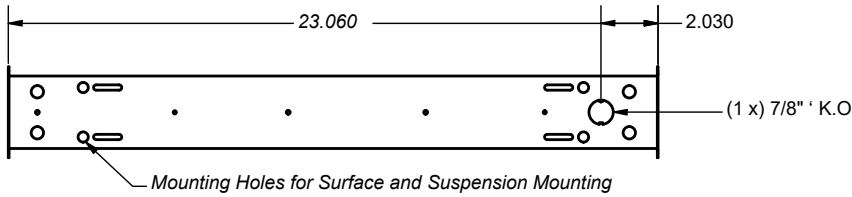

### 2FT End View

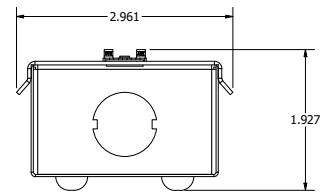

### BLSPC, 4 Foot Side Dims

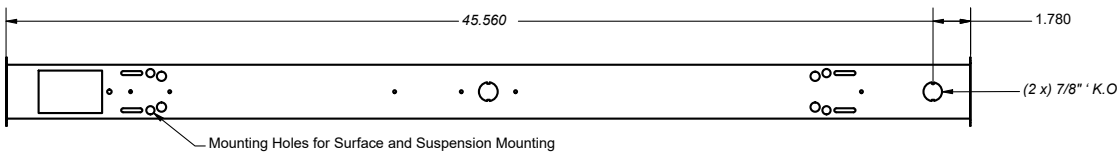

### 4FT End View

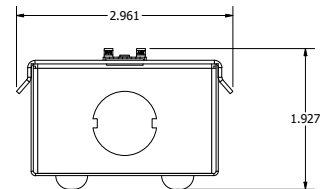

### BLSPC, 8 Foot Side Dims

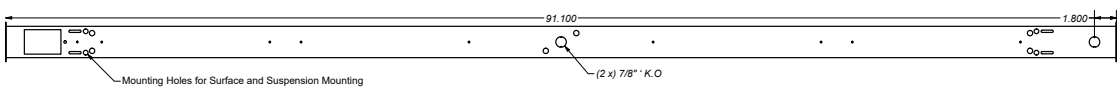

### 8FT End View

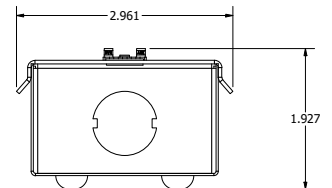

- \* Drawings aren't to scale
- \* Standard tolerances apply
- \* Specifications may change without notice

## BLSPC-4FT-5.5L-840-L18

### Cone of Light

Mtg Height	Light Level	Beam Diameter
6.0 ft	60.0 fc	18.8 ft
8.0 ft	33.8 fc	25.0 ft
10.0 ft	21.6 fc	31.3 ft
12.0 ft	15.0 fc	37.6 ft
14.0 ft	11.0 fc	43.8 ft
16.0 ft	8.4 fc	50.1 ft

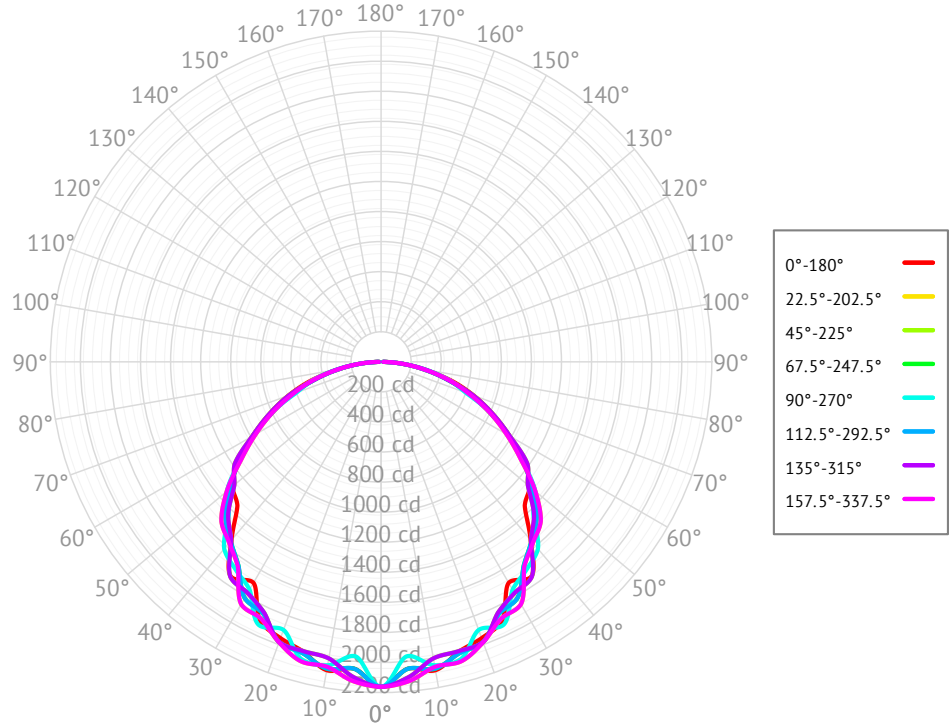

Based on 'BLSPC-4FT-5.5L-840-L18', ie. (BLSPC, 4 foot, 5500lm, 80 CRI, 4000K, w/ L18 Frosted Lens)

## BLSPC-8FT-11L-840-L18

### Cone of Light

Mtg Height	Light Level	Beam Diameter
6.0 ft	112.8 fc	22.1 ft
8.0 ft	63.5 fc	29.5 ft
10.0 ft	40.6 fc	36.9 ft
12.0 ft	28.2 fc	44.2 ft
14.0 ft	20.7 fc	51.6 ft
16.0 ft	15.9 fc	59.0 ft

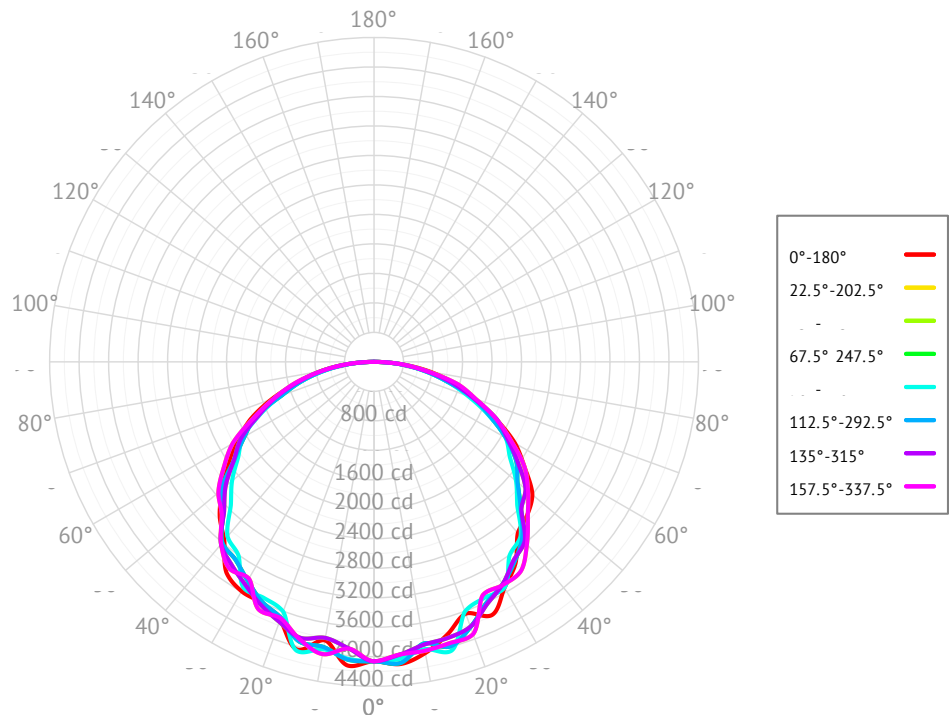

Based on 'BLSPC-8FT-11L-840-L18', ie. (BLSPC, 8 foot, 11000lm, 80 CRI, 4000K, w/ L18 Frosted Lens)

## Modular Wiring

The BLSPC has options for modular wiring. Below you will find the diagrams for these wiring options, and the relevant option codes necessary for ordering them.

### W22XY - Molex Row Mounting Wiring

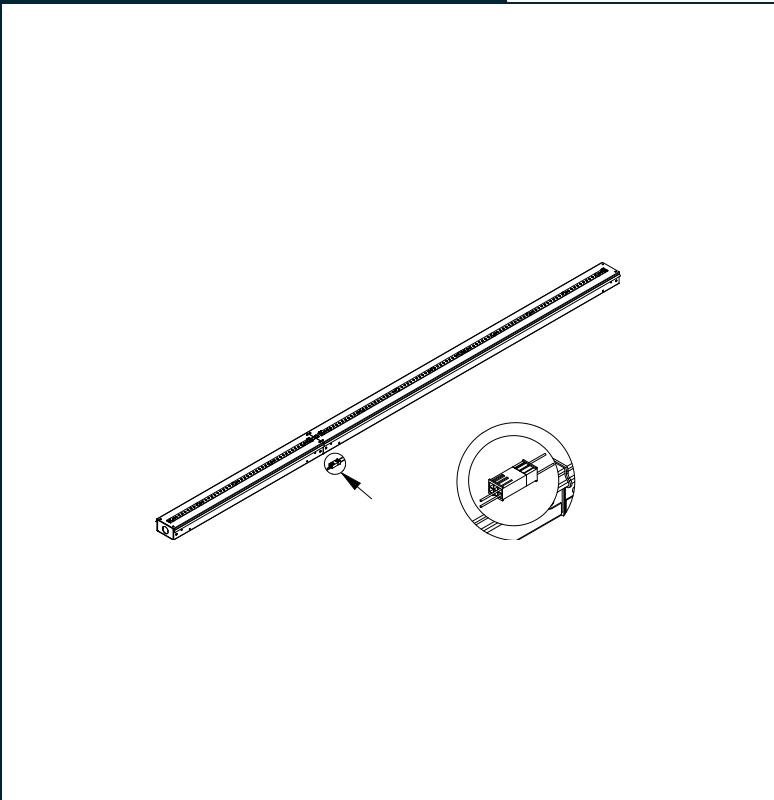

### W27XYZC - Modular Power Cable

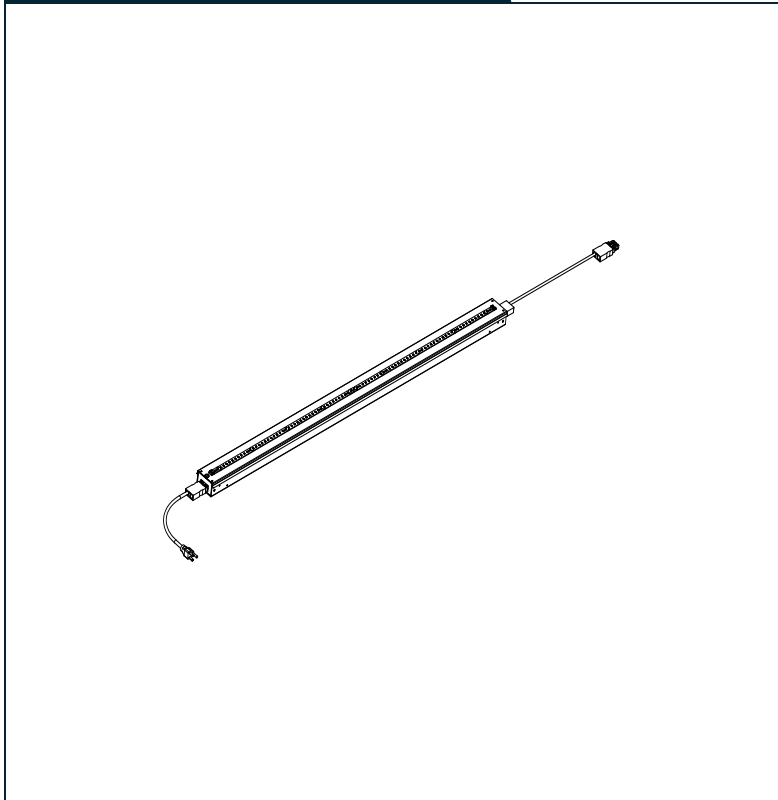

### W22XY - Molex Row Mounting Wiring

X - Style	Y - Poles
E - End	3 - 3 Pole
.	4 - 4 Pole
.	5 - 5 Pole
.	6 - 6 Pole

Example: **W22E6** (see image above)

### W27XYZC - Modular Power Cable

X - Style	Y - Poles	Z - Wiring	C - Colour
S - Side	3 - 3 Pole	Blank - Standard	Blank - White
E - End	4 - 4 Pole	E - End of Row	B - Black
T - Top	5 - 5 Pole	.	G - Grey
.	6 - 6 Pole	.	.

Example: **W27E3** (see image above)

## Emergency Battery Plan - 10W

Emergency Lighting	Solution System Components	System Operation
Option Code 'B17' - UL 924 listed components that are factory installed in the luminaire	UL 924 listed 10-watt battery integral to the luminaire	Loss of normal power is detected by the B17 emergency light solution and the power supply is switched automatically to the 10-watt integral battery pack which powers the emergency LED lighting driver.
	UL 924 listed LED emergency lighting driver integral to the luminaire	The battery pack and emergency LED driver are UL 924 certified to provide a minimum of 90-minutes of emergency lighting.
	Wiring options for both switched and unswitched emergency lighting	

## Emergency Lighting Wiring

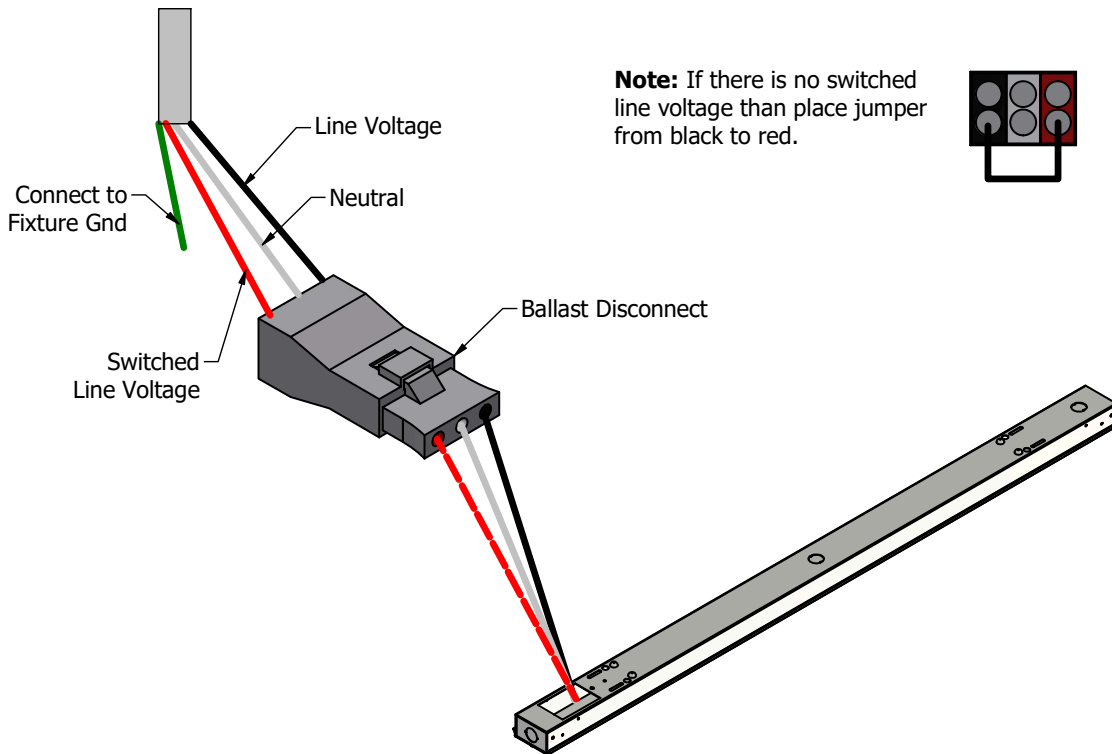

## Important Information

More information on emergency lighting options and configurations available on request.